

Rev.	01	Modify	-	Date	2017.02.27	Signed	SUGLIANI	Approved	CIMMINO
Rev.		Modify		Date		Signed		Approved	
Rev.		Modify		Date		Signed		Approved	

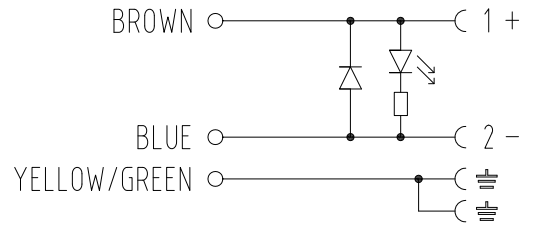

CONNECTOR FEATURES	
PRODUCT TYPE	SQUARE CONNECTOR EN175301-803(type-A)
CONNECTOR COLOUR	BLACK
CONTACTS SPACING	18mm
NUMBER OF CONTACTS	2POLES+2EARTHS
EARTH POSITIONING	H.6-12
CENTRAL FIXING SCREW	M3X0,5 L=25mm
GASKET TYPE	INTEGRATED (NBR)
PROTECTION CLASS	IP67
CIRCUIT TYPE	RED LED+DIODE(1A)
RATED VOLTAGE	24V DC
CONNECTOR WITH H.T.P.LOGO	
CABLE FEATURES	
H.T.P.CABLE CODE	CAVO 06
NUMBER OF CONDUCTORS	N°3
CONDUCTORS SECTION	1mm ²
CABLE MATERIAL	PVC CEI20221I0R
COATING COLOUR	GREY RAL7032
CONDUCTORS INSULATION MATERIAL	PVC
CABLE LENGHT	6000mm
STRIPPING	35mm STANDARD
PEELING AND TINNING	5mm STANDARD
ON THE CABLE, NEAR THE CONNECTOR HEAD, MUST BE SILK PRINTED THE H.T.P. PRODUCTION DATE CODE 5#####	

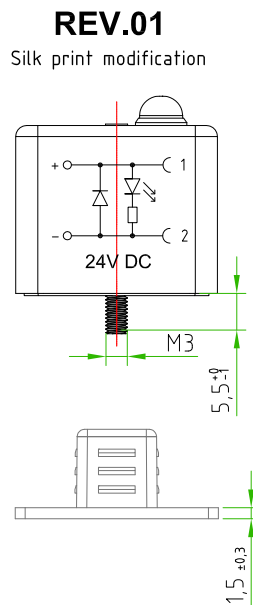
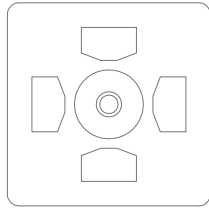
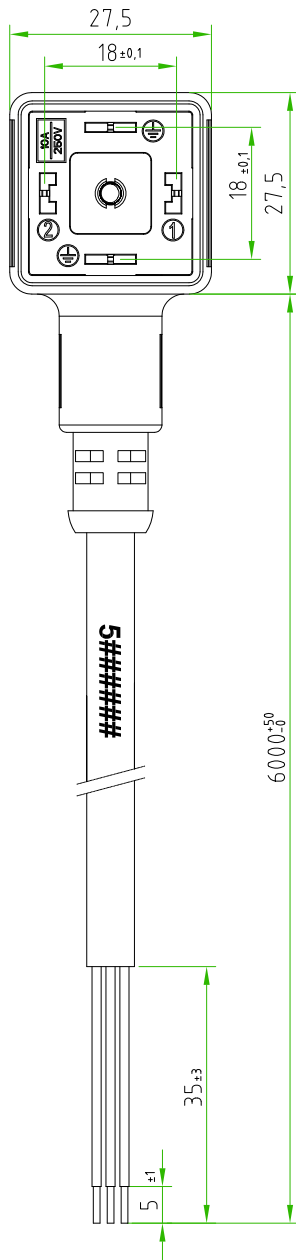
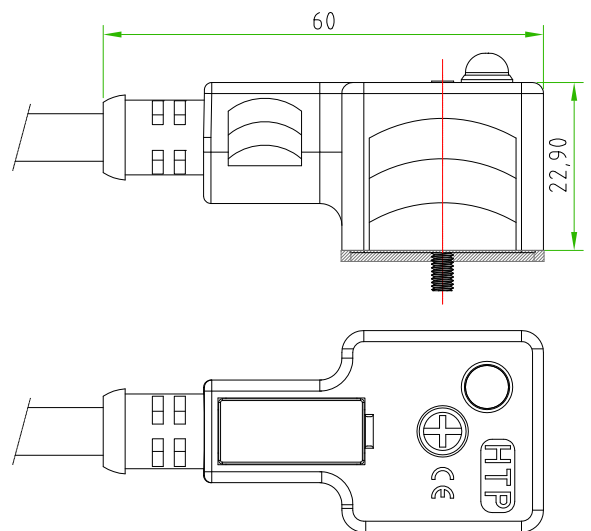

CUSTOMER APPROVAL

SIGNATURE	DATE

PLEASE SIGN AND RETURN

Designer	SUGLIANI R.	Date	2016-03-23	Tolerance	±0.3	Units:	mm	Series	EN175301-803	Drawing n. 1-1
Approved	CIMMINO L.	Date	2016-03-23	Scale	1:1	Size:	A4	Customer code:		



DESCRIPTION
SQUARE CONNECTOR EN175301-803(type-A), 2P.+P.E., BLACK, WITH RED LED +DIODE(1A), 24V DC, WITH CABLE PVC/PVC, CEI20221I0R, 3G1mm², GREY COLOUR, L=6m CONNECTOR WITH H.T.P.LOGO

H.T.P.PART NUMBER

CG1N02DL1C066