

Rev.	Modify	Date	Signed	Approved

Rev.	Modify	Date	Signed	Approved

Rev.	Modify	Date	Signed	Approved

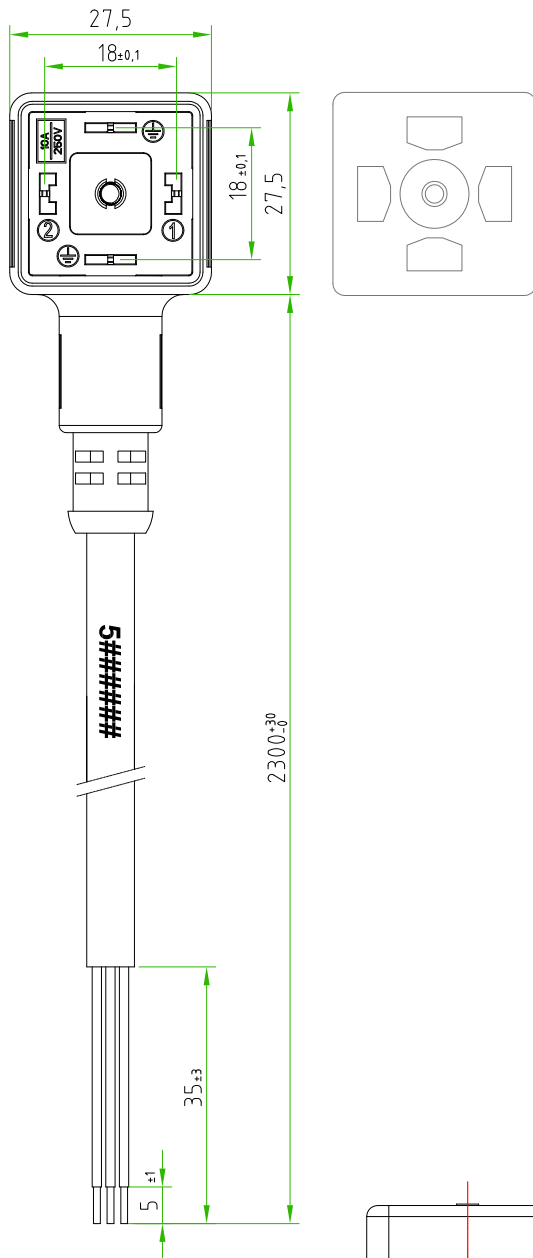

CONNECTOR FEATURES	
PRODUCT TYPE	SQUARE CONNECTOR EN175301-803(type-A)
CONNECTOR COLOUR	BLACK
CONTACTS SPACING	18mm
NUMBER OF CONTACTS	2POLES+2EARTHS
EARTH POSITIONING	H.6-12
CENTRAL FIXING SCREW	M3X0,5 L=25mm
GASKET TYPE	INTEGRATED (NBR)
PROTECTION CLASS	IP67
CIRCUIT TYPE	WITHOUT ELECTRONIC
RATED VOLTAGE	250V AC / 300V DC
CONNECTOR WITH H.T.P.LOGO	
CABLE FEATURES	
H.T.P.CABLE CODE	CAVO 03
NUMBER OF CONDUCTORS	N°3
CONDUCTORS SECTION	0,75mm ²
CABLE MATERIAL	PVC CEI2022IIOR
COATING COLOUR	GREY RAL7032
CONDUCTORS INSULATION MATERIAL	PVC
CABLE LENGHT	2300mm
STRIPPING	35mm STANDARD
PEELING AND TINNING	5mm STANDARD
ON THE CABLE, NEAR THE CONNECTOR HEAD, MUST BE SILK PRINTED THE H.T.P. PRODUCTION DATE CODE 5#####	

CUSTOMER APPROVAL	
SIGNATURE	DATE
PLEASE SIGN AND RETURN	

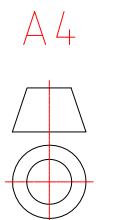
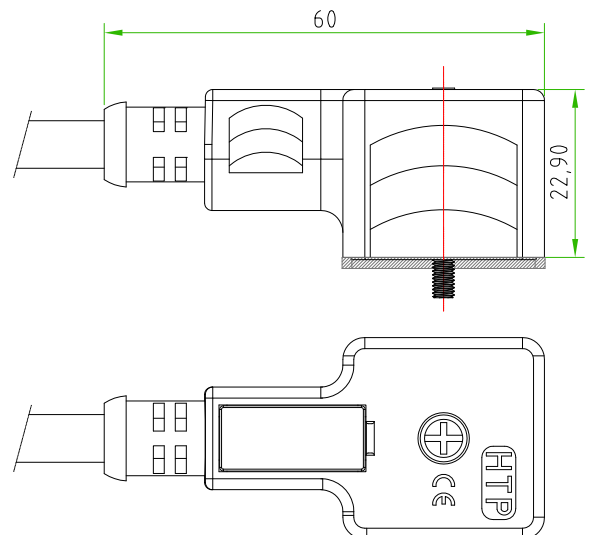
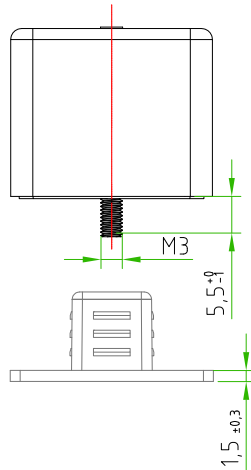

Designer	SUGLIANI R.	Date	2016-03-23	Tolerance	±0.3	Units:	mm	Series	EN175301-803	Drawing n. 1-1
Approved	CIMMINO L.	Date	2016-03-23	Scale	1:1	Size:	A4	Customer code:		

	DESCRIPTION	H.T.P.PART NUMBER
	SQUARE CONNECTOR EN175301-803(type-A), 2P. +P.E., BLACK, WITHOUT ELECTRONIC, 250V AC / 300V DC, WITH CABLE PVC/PVC, CEI2022IIOR, 3G0.75mm ² , GREY COLOUR, L=2,3m CONNECTOR WITH H.T.P.LOGO	CG1N02000C032C