

Rev.	Modify	Date	Signed	Approved

Rev.	Modify	Date	Signed	Approved

Rev.	Modify	Date	Signed	Approved
01	-	2018.10.09	SUGLIANI CIMMINO	CIMMINO SUGLIANI
02	-	2019.01.03	CIMMINO	SUGLIANI

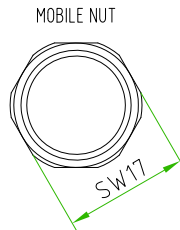
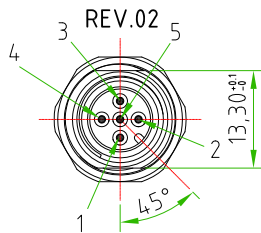
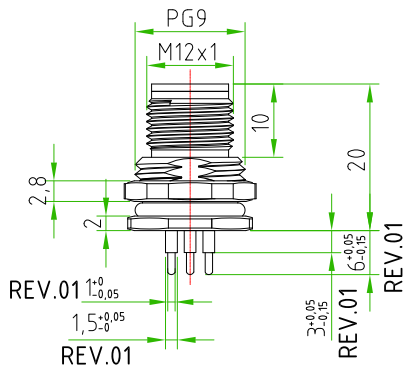
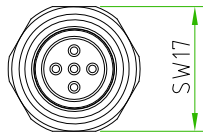
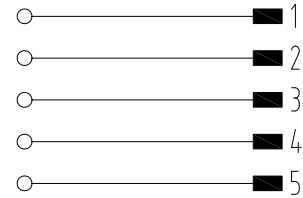

CONNECTOR FEATURES	PRODUCT TYPE	M12 CIRCULAR CONNECTOR TO PANEL WITH CONTACTS SUITABLE FOR PCB
	TYPE MOUNTING	BACK MOUNTING
	CONTACTS TYPE	MALE 5POLES
	NUMBER OF CONTACTS CONNECTED	N°5
	HOUSING MATERIAL	BRASS+NICKEL PLATED
	O-RING MATERIAL	NBR
	FIXING THREAD	PG9
	SIZE CUT	13,30mm (+0,1/-0)
	SIZE FIXED NUT(SW)	SW17
	SIZE MOBILE NUT(SW)	SW17
	PROTECTION CLASS	IP67
	RATED VOLTAGE	60V AC/DC
	RATED CURRENT	4A
	CONNECTOR WITHOUT ANY LOGO	



PAY ATTENTION to the position of the polarization key towards the CUT and the exagonal fixing nut.

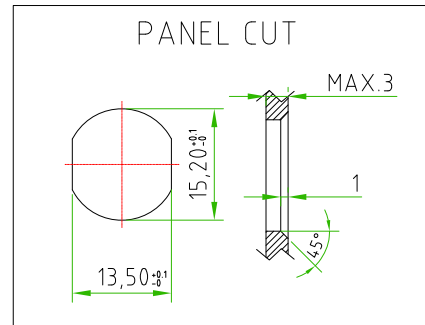

CUSTOMER APPROVAL	
SIGNATURE	DATE
PLEASE SIGN AND RETURN	

A4

Designer	SUGLIANI R.	Date	2017-04-05	Tolerance	±0.3	Units:	mm	Series	M12	Drawing n.
Approved	CIMMINO L.	Date	2017-04-05	Scale	1:1	Size:	A4	Customer code:		

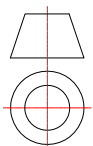

DESCRIPTION

CIRCULAR CONNECTOR M12, MALE, TO PANEL, 5POLES, BACK MOUNTING, PG9 THREAD, COMPLETE WITH CUT, WITH CONTACTS SUITABLE TO BE SOLDERED ON PCB. CONNECTOR WITHOUT ANY LOGO

H.T.P.PART NUMBER

12MS5000-PG9-CUT