

Rev.	Modify	Date	Signed	Approved

Rev.	Modify	Date	Signed	Approved

Rev.	Modify	Date	Signed	Approved
01	-	2021.04.27	SUGLIANI CIMMINO	

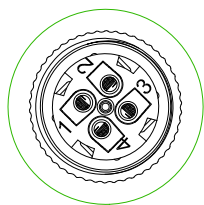

!
ON THE INTERNAL CORE
MUST BE SILK PRINTED
THE CONTACTS NUMBERS

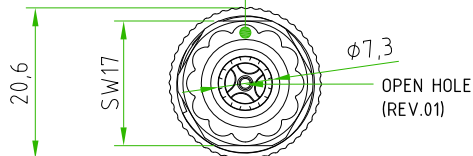
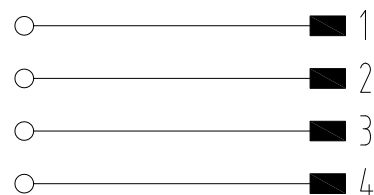

REV.01

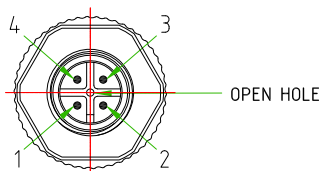
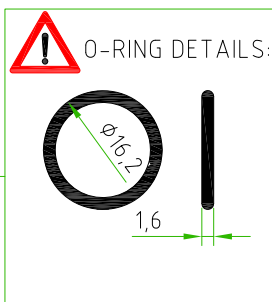
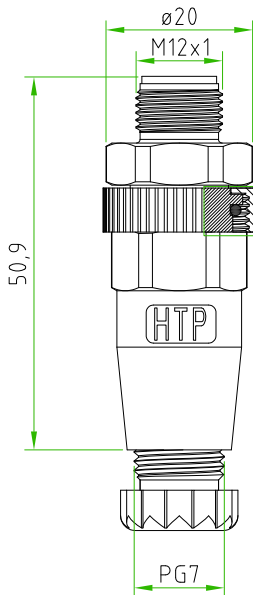

CONNECTOR FEATURES	PRODUCT TYPE	M12 CIRCULAR CONNECTOR FIELD ATTACHABLE
	CONNECTOR TYPE	STRAIGHT 180°
	HOUSING MATERIAL/COLOUR	PA66+30%GF/BLACK
	PRESS-CABLE MATERIAL/COLOUR	PA66/BLACK
	INTERNAL CORE MATERIAL/COLOUR	PA66/BLACK
	M12 COUPLING NUT MATERIAL	HEXAGONAL (SW17) STAINLESS STEEL (AISI304)
	CONTACTS TYPE	MALE SCREW CONTACTS
	NUMBER OF POLES	4POLES (5HOLES)
	CABLE EXIT	PG7
	SUITABLE CABLE	FROM 4mm TO 6mm
	MAX.CONDUCTOR SIZE	0,75mm ² (AWG18)
	PROTECTION CLASS	IP67
	RATED VOLTAGE	250V AC/DC
	RATED CURRENT	4A
	CONNECTOR TEMPERATURE RANGE	from -40°C to +90°C
	SEAL MATERIAL	PVC
CONNECTOR WITH H.T.P. LOGO		
! PACKAGING: SINGLY PACKED IN THE PLASTIC BAG (PLASTIC BAG WITHOUT ANY LOGO AND LABEL)		

CUSTOMER APPROVAL

SIGNATURE	DATE

PLEASE SIGN AND RETURN

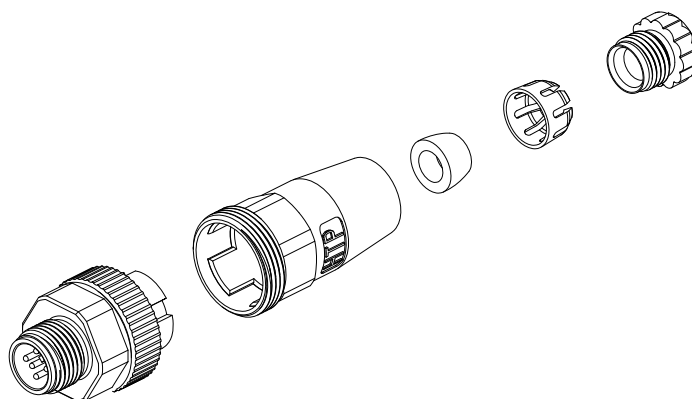

Designer	SUGLIANI R.	Date	2021-03-02	Tolerance	±0.3	Units:	mm	Series	M12	Drawing n.
Approved	CIMMINO L.	Date	2021-03-02	Scale	1:1	Size:	A4	Customer code:		



DESCRIPTION
CIRCULAR CONNECTOR M12 FIELD ATTACHABLE, MALE STRAIGHT 180°, 4POLES(5HOLES), WITH HEXAGONAL STAINLESS STEEL AISI304 NUT, PG7 EXIT CABLE.
CONNECTOR WITH H.T.P.LOGO

H.T.P.PART NUMBER

12MC4000-INOX

