

Rev.		Approved	
Modify		Signed	
Date			

Rev.		Approved	
Modify		Signed	
Date			

Rev.	01	Signed	SUGLIANI	Approved	CIMMINO
Modify	-				
Date	2021.04.27				

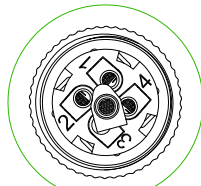

!
ON THE INTERNAL CORE
MUST BE SILK PRINTED
THE CONTACTS NUMBERS

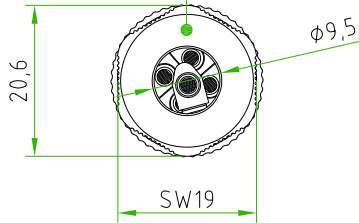
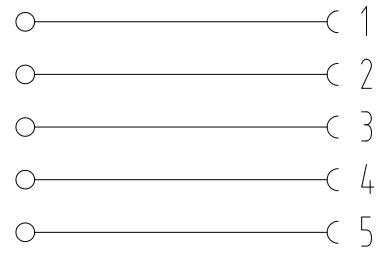

REV.01

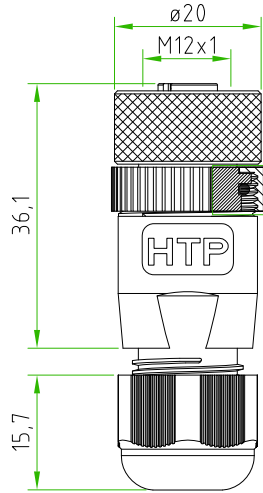
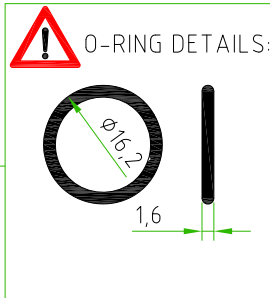

PRODUCT TYPE	M12 CIRCULAR CONNECTOR FIELD ATTACHABLE
CONNECTOR TYPE	STRAIGHT 180°
HOUSING MATERIAL/COLOUR	PA66+30%GF/BLACK
PRESS-CABLE MATERIAL/COLOUR	PA66/BLACK
INTERNAL CORE MATERIAL/COLOUR	PA66/BLACK
M12 COUPLING NUT MATERIAL	BRASS + NICKEL PLATED
CONTACTS TYPE	FEMALE SCREW CONTACTS
NUMBER OF POLES	5POLES
CABLE EXIT	SK
SUITABLE CABLE	FROM \varnothing 4mm TO \varnothing 8.6mm
MAX.CONDUCTOR SIZE	0,75mm ² (AWG18)
PROTECTION CLASS	IP67
RATED VOLTAGE	60V AC/DC
RATED CURRENT	4A
CONNECTOR TEMPERATURE RANGE	from -40°C to +90°C
DOUBLE SEAL MATERIAL	PVC
CONNECTOR WITH H.T.P. LOGO	
! PACKAGING: SINGLY PACKED IN THE PLASTIC BAG (PLASTIC BAG WITHOUT ANY LOGO AND LABEL)	

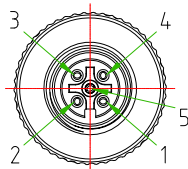

CUSTOMER APPROVAL

SIGNATURE DATE

**PLEASE SIGN
AND RETURN**

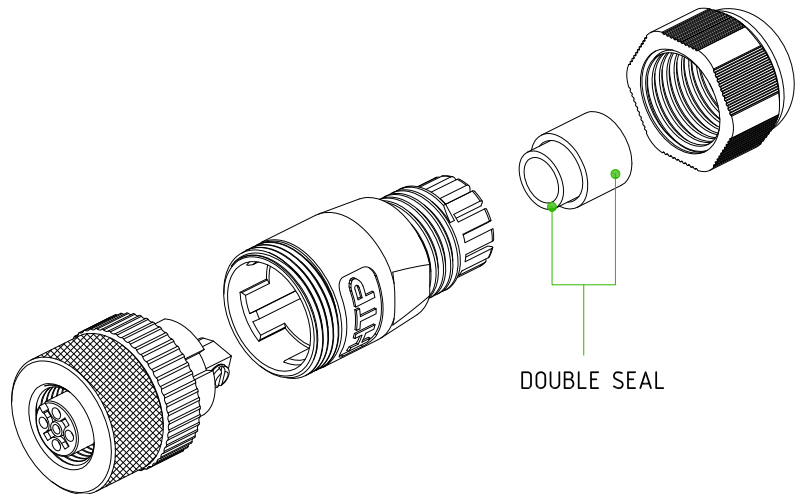

DOUBLE SEAL

Designer	CIMMINO L.	Date	2018-07-27	Tolerance	±0.3	Units:	mm	Series	M12	Drawing n.
Approved	SUGLIANI R.	Date	2018-07-27	Scale	1:1	Size:	A4	Customer code:		



DESCRIPTION
CIRCULAR CONNECTOR M12 FIELD ATTACHABLE, FEMALE, STRAIGHT 180°,
5POLES, EXIT CABLE FROM \varnothing 4mm TO \varnothing 8.6mm
CONNECTOR WITH H.T.P. LOGO

H.T.P. PART NUMBER

12FC5000-SK

A4

